



SONOMA CAST STONE CORPORATION
 133 COBELAND STREET PETALUMA, CA 94952
 707-283-1888
 FAX 707-283-1899

Custom CounterSinks - Rectangular

DATE : 12/18/2020 DRAWN BY: CF

RECTANGULAR "SCOOP"

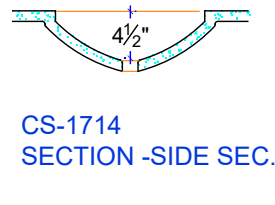
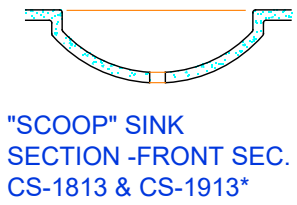
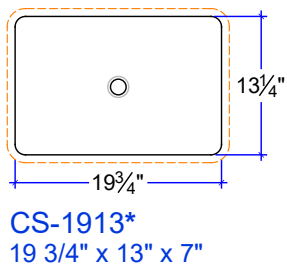
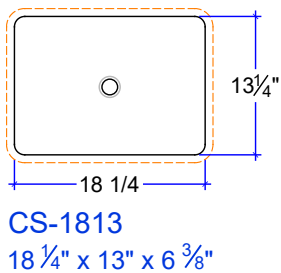
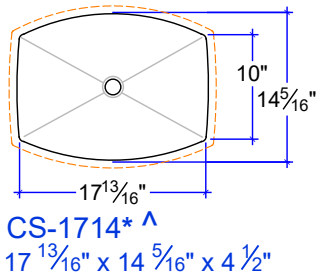

RECTANGULAR "CRESCENT"

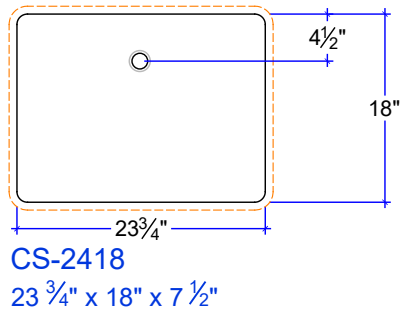
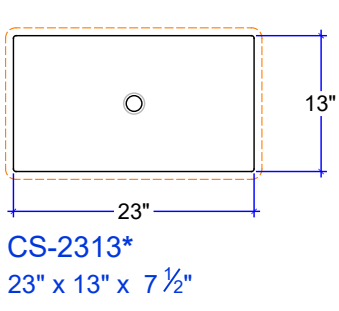
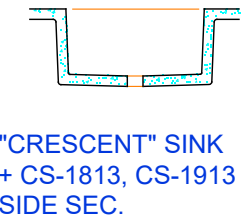
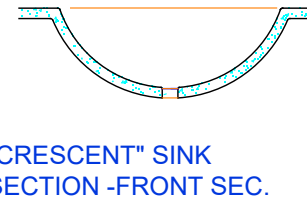
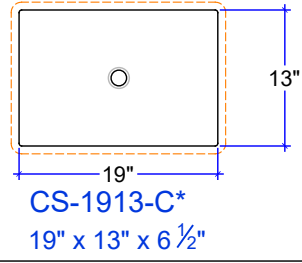
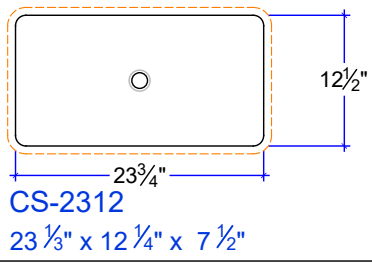

RECTANGULAR "WEDGE"

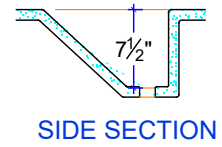
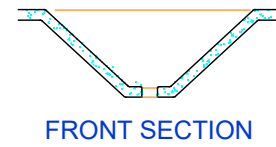
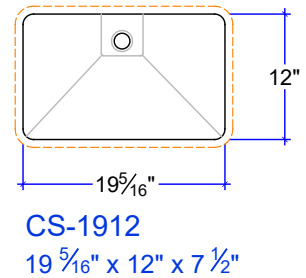
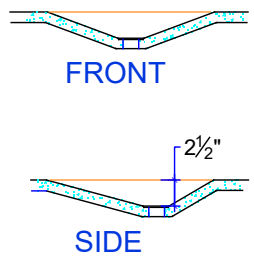
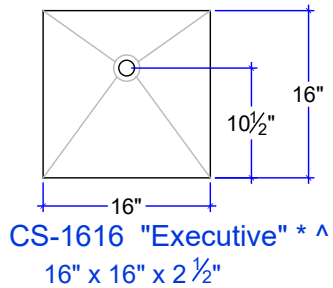

SIDE SLOPE CURVED

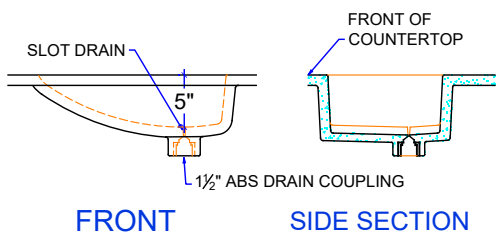
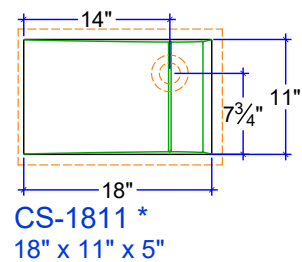

DIMENSIONS ARE INSIDE SINK

* THESE MODELS ARE AVAILABLE AS MULTIPLE-SINK VANITIES
 ^ THESE MODELS CAN COMPLY WITH A.D.A. STANDARDS