

COUNTERSINKS, RECTANGULAR, PAGE 3

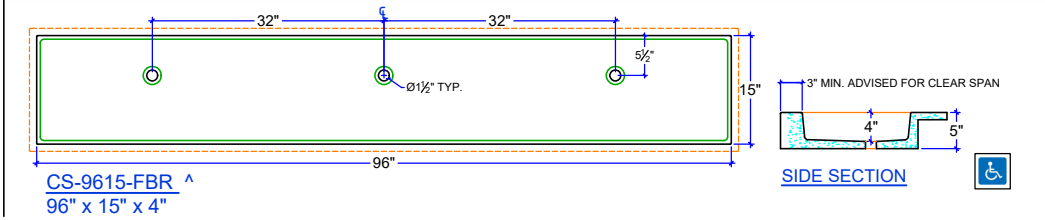

NOTE: ALL BASINS MAY ALSO BE PRODUCED AS UNDERMOUNTS IN SEPARATE COUNTER, OR AS COUNTERTOP VESSELS

Note: Overflows are available by special order

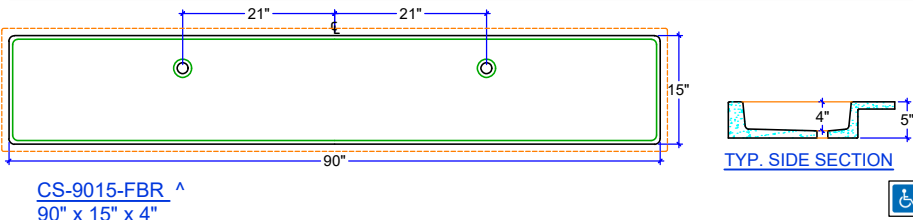
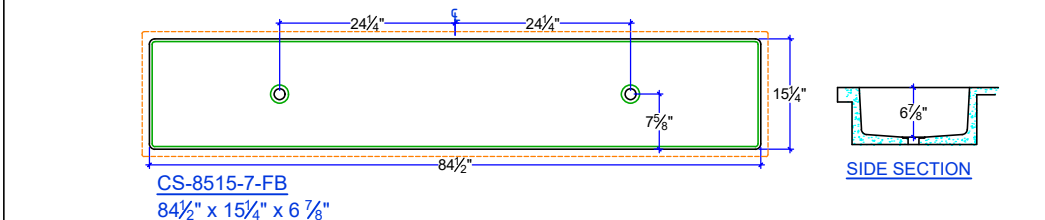
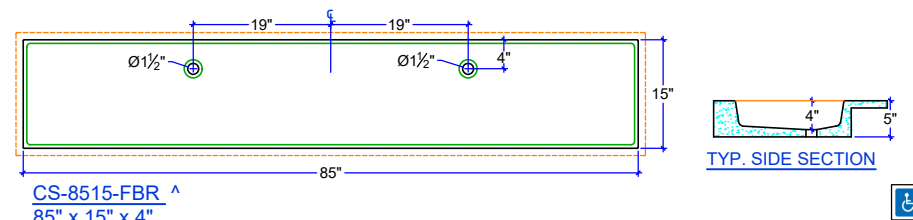
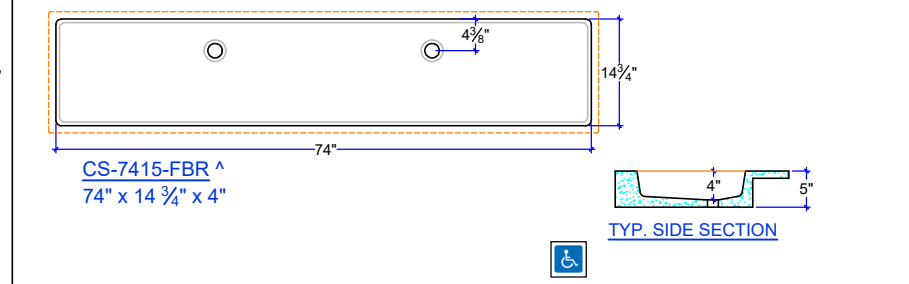
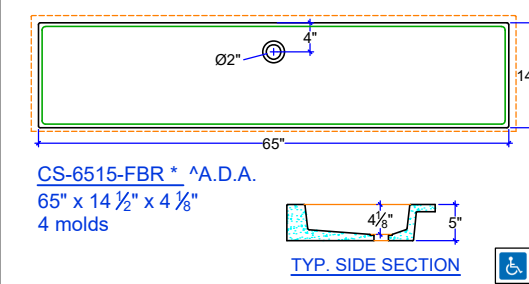
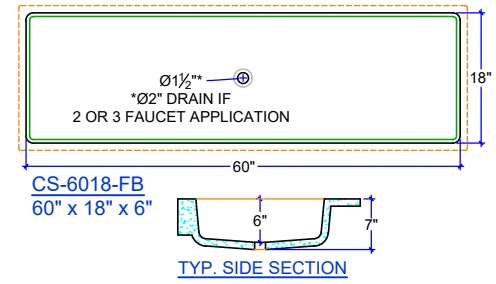
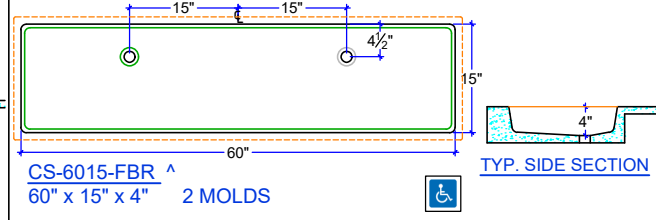
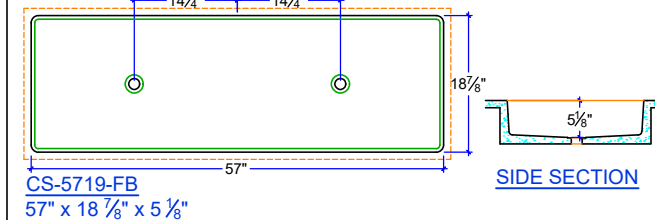
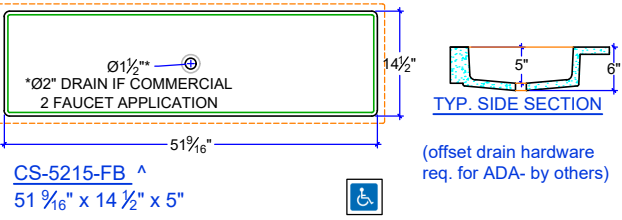
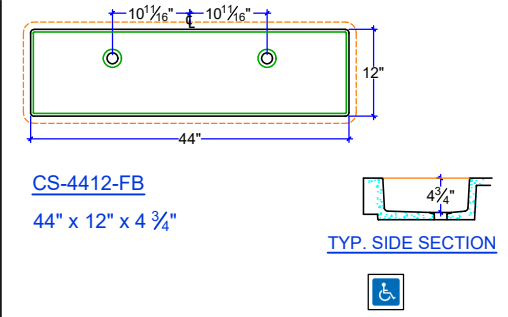
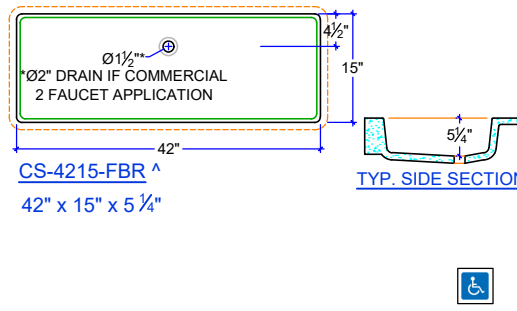
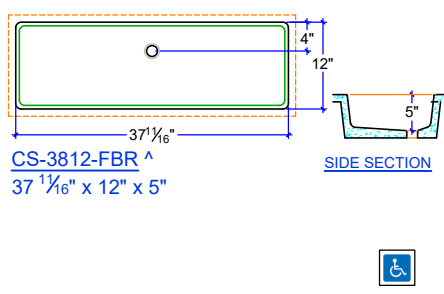
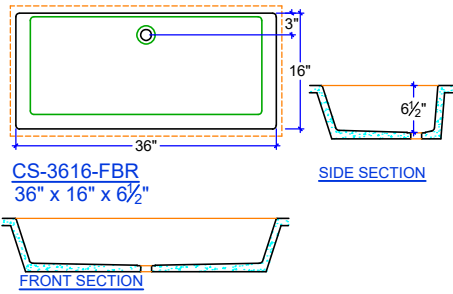

INTEGRAL COUNTERSINKS, RECTANGULAR
CUSTOM SIZE COUNTERTOP WITH FIXED SIZE BASIN
DIMENSIONS ARE INSIDE SINK

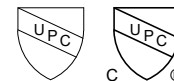

IAPMO Certificate of Listing #4816

(877)283-2400
www.sonomastone.com
sales@sonomastone.com
All rights reserved