

# WV-COM-4, 1-2-1 VARIANT

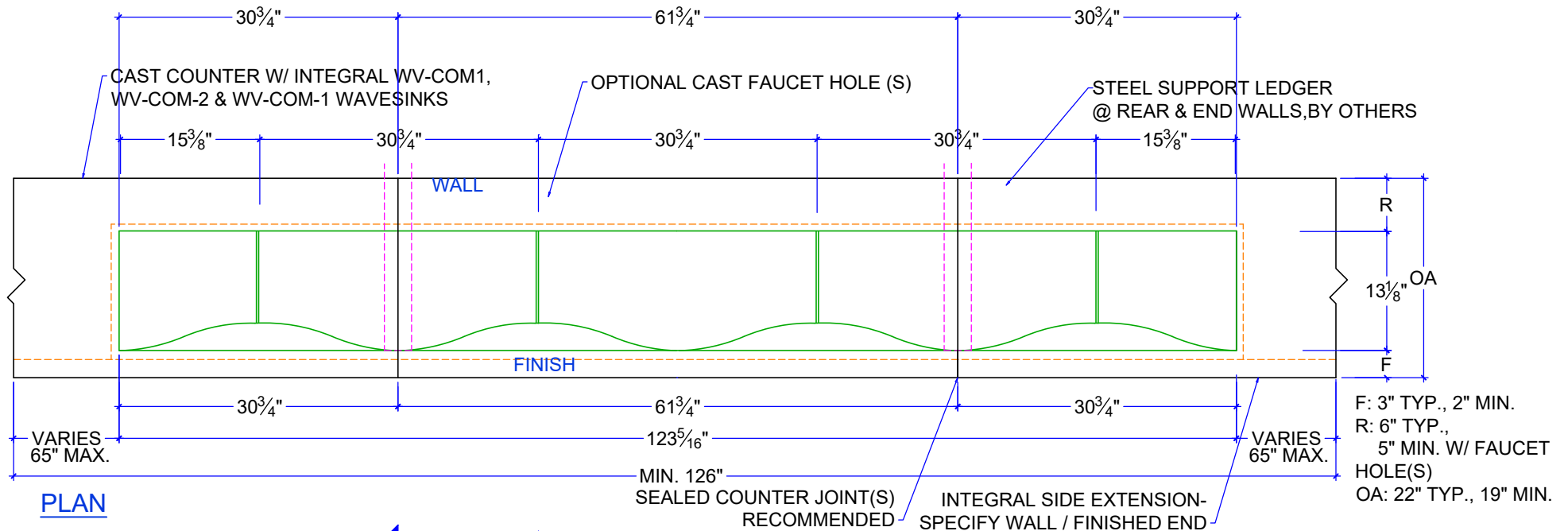

PLAN

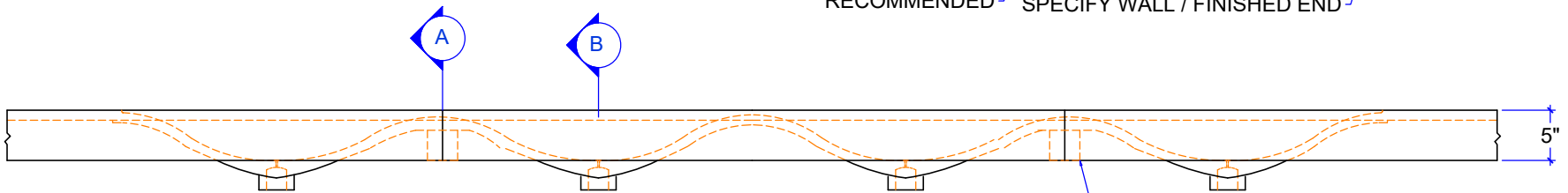

FRONT ELEVATION

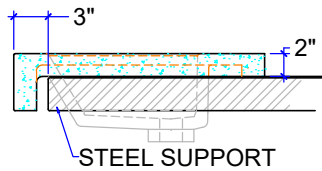

SECTION A

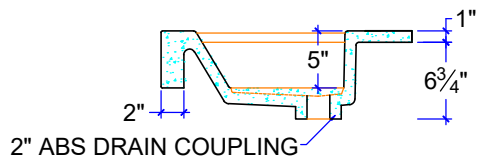

SECTION B

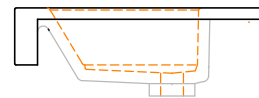

WALL END

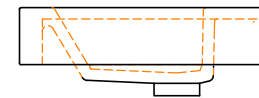

FINISH END



WAVESINK, QUADRUPLE COMMERCIAL 1-2-1  
 CUSTOM SIZE COUNTERTOP WITH FIXED SIZE BASIN  
 DIMENSIONS ARE INSIDE SINK

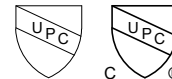

IAPMO Certificate of Listing #4816



(877)283-2400  
 www.sonomastone.com  
 sales@sonomastone.com  
 All rights reserved